

### HIGH-TEMPERATURE, 40V DIODE FAMILY

#### FEATURES

- ▲ Reverse voltage  $V_R > 55V$ .
- ▲ Operational beyond the  $-60^\circ C$  to  $+230^\circ C$  temperature range.
- ▲ Forward current @  $230^\circ C$ ,  $V_F=1.2V$ :
  - XTR1N0415:  $I_F=280mA$  per diode.
  - XTR1N0450:  $I_F=800mA$  per diode.
- ▲ Forward voltage @  $85^\circ C$ ,  $I_F=1mA$ :
  - XTR1N0415:  $V_F=622mV$  per diode.
  - XTR1N0450:  $V_F=585mV$  per diode.
- ▲ Ruggedized SMT and thru-hole packages.
- ▲ Also available as bare die.

#### APPLICATIONS

- ▲ Reliability-critical, Automotive, Aeronautics & Aerospace, Down-hole.
- ▲ General rectification, voltage blocking and clamping, power supplies.

#### DESCRIPTION

XTR1N0400 is a family of general purpose diodes with a reverse voltage above 55V. Each part is composed of two or four independent diodes which can be used individually, in half- or full-bridge rectifier architectures or connected in series or parallel. Typical applications include rectification, demodulation, voltage blocking, voltage clamping, power supplies, charge pumps and voltage multipliers. Full functionality is guaranteed from  $-60^\circ C$  to  $+230^\circ C$ , though operation well below and above this temperature range is achieved. XTR1N0400 parts have been designed to reduce system cost and ease adoption by reducing the learning curve and providing easy to use features. Parts from the XTR1N0400 family are available in ruggedized SMT and thru-hole packages. Parts are also available as bare dies.

#### PRODUCT HIGHLIGHT

Diodes used in half- and full-wave rectification as well as voltage clamping in flyback application

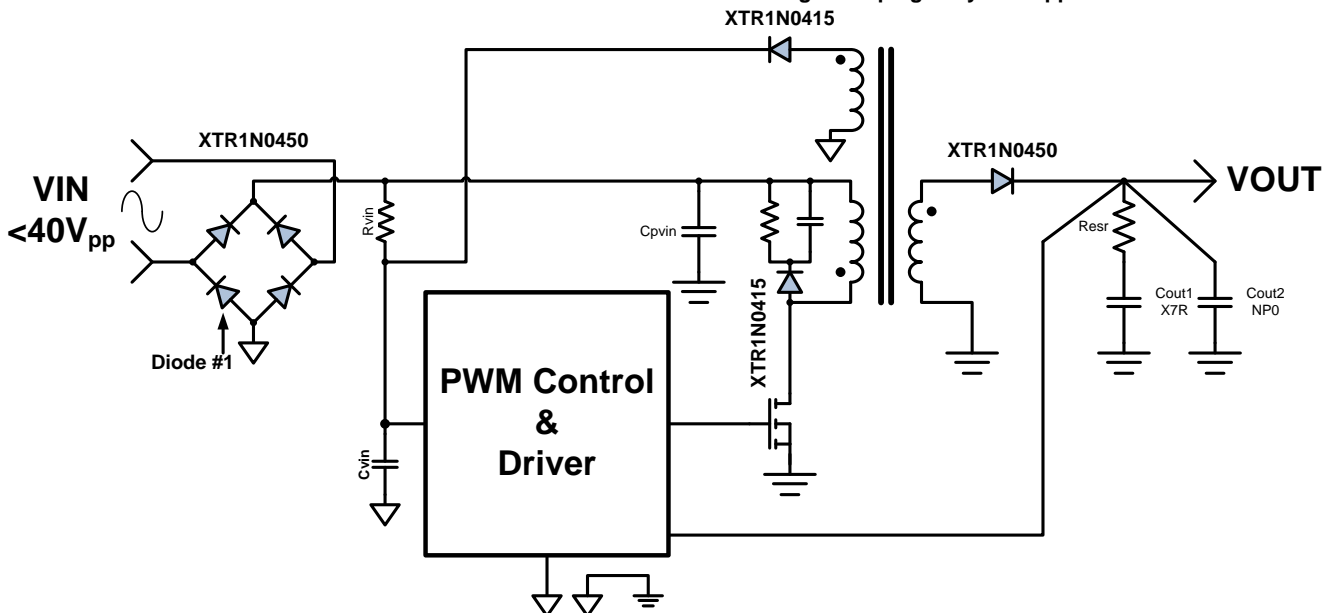

#### ORDERING INFORMATION



Product Reference	Temperature Range	Package	Pin Count	Marking
XTR1N0415-D	$-60^\circ C$ to $+230^\circ C$	Ceramic side brazed DIP	8	XTR1N0415
XTR1N0415-FE	$-60^\circ C$ to $+230^\circ C$	Gull-wing flat pack with ePad	8	XTR1N0415
XTR1N0415-T	$-60^\circ C$ to $+230^\circ C$	TO-18 metal can	3	XTR1N0415
XTR1N0415-TD	$-60^\circ C$ to $+230^\circ C$	Tested bare die		
XTR1N0450-D	$-60^\circ C$ to $+230^\circ C$	Ceramic side brazed DIP	8	XTR1N0450
XTR1N0450-TD	$-60^\circ C$ to $+230^\circ C$	Tested bare die		

Other packages and packaging configurations possible upon request. For some packages or packaging configurations, MOQ may apply.

## ABSOLUTE MAXIMUM RATINGS

Repetitive peak reverse voltage $V_{RRM}$	55V
Continuous peak reverse voltage $V_R$	55V
Continuous forward current $I_F$ @230°C	
XTR1N0415	0.63A
XTR1N0450	1.80A
Operating Junction Temperature Range	-70°C to +300°C

**Caution:** Stresses beyond those listed in “ABSOLUTE MAXIMUM RATINGS” may cause permanent damage to the device. These are stress ratings only and functionality of the device at these or any other condition beyond those indicated in the operational sections of the specifications is not implied. Exposure to “ABSOLUTE MAXIMUM RATINGS” conditions for extended periods may permanently affect device reliability.

## PACKAGING OPTIONS

### Side Brazed DIP8 XTR1N04XX-D

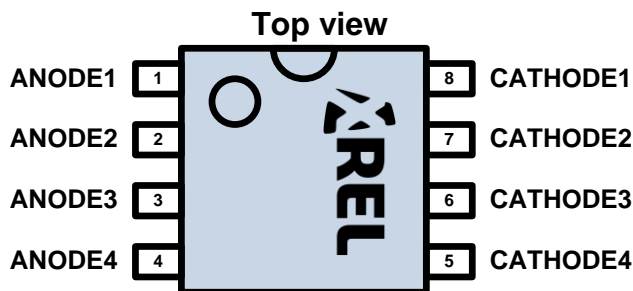

### CDFP8 with ePad XTR1N0415-FE

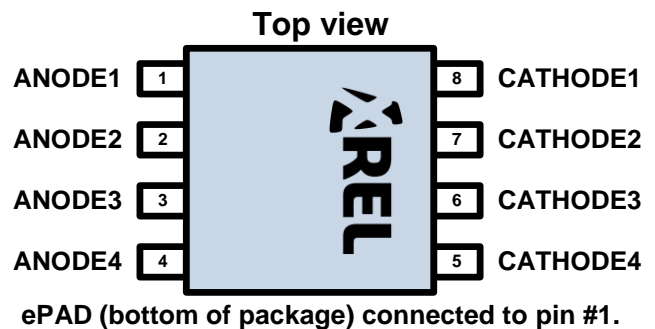

### TO-18 XTR1N0415-T

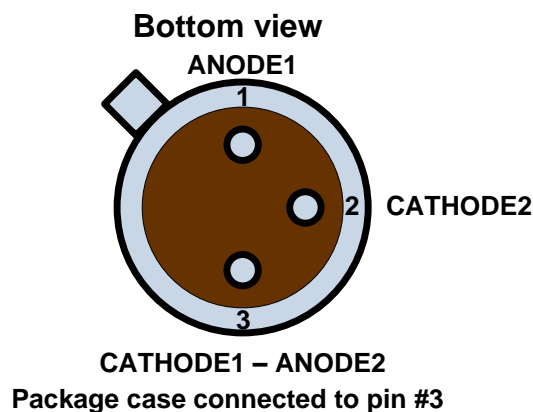

## BLOCK DIAGRAM

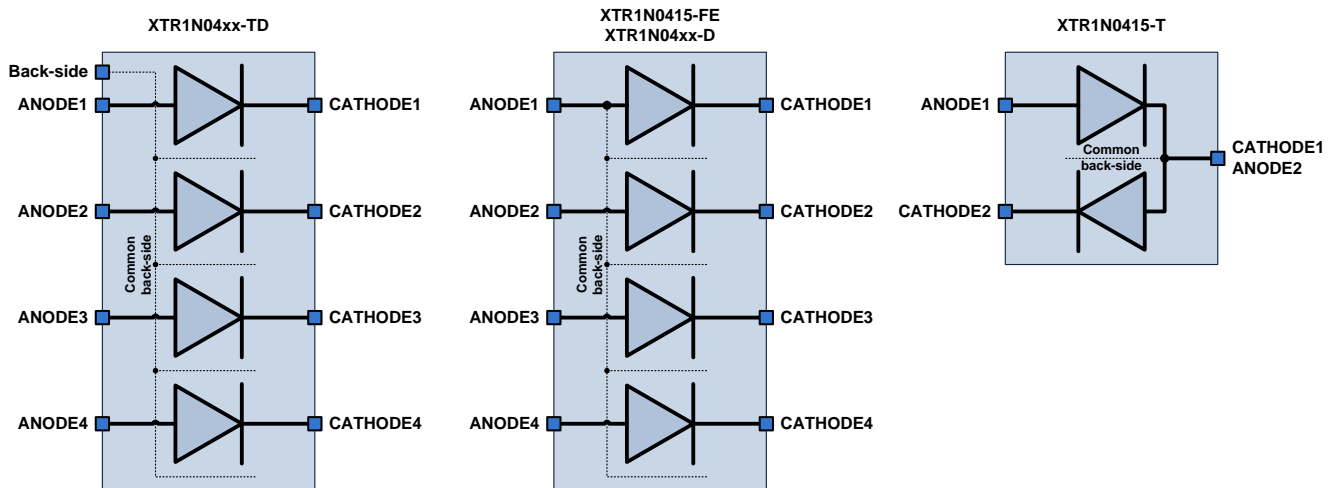

### Important Notices:

Dashed lines indicate the back side connection for the different packages.

For best reverse voltage performance, the back-side must be connected to the most negative voltage seen by the diodes.

In case a diode is not used, the diode should be shorted and tied to a fixed voltage in the application or at least to a terminal of any active diode.

## THERMAL CHARACTERISTICS

Parameter	Condition	Min	Typ	Max	Units
<b>XTR1N04XX-D (DIP8)</b>					
Thermal Resistance: J-C $R_{Th\_J-C}$			20		°C/W
Thermal Resistance: J-A $R_{Th\_J-A}$	Still air.		100		°C/W
<b>XTR1N0415-FE (DFP8 with exposed pad)</b>					
Thermal Resistance: J-C $R_{Th\_J-C}$	Measured on ePAD.		10		°C/W
Thermal Resistance: J-A $R_{Th\_J-A}$	ePAD thermally connected to 3cm <sup>2</sup> PCB copper		75		°C/W
<b>XTR1N0415-T (TO-18)</b>					
Thermal Resistance: J-C $R_{Th\_J-C}$			50		°C/W
Thermal Resistance: J-A $R_{Th\_J-A}$	Still air.		300		°C/W

## RECOMMENDED OPERATING CONDITIONS

Parameter	Min	Typ	Max	Units
Reverse voltage $V_R$			40	V
Forward voltage $V_F$			1.5	V
Continuous forward current per diode @ $V_F=1.5V, T_J=85^\circ C$ $I_F$				
<b>XTR1N0415</b>		0.45		A
<b>XTR1N0450</b>		1.30		A
Junction Temperature <sup>1</sup> $T_J$	-60		230	°C

<sup>1</sup> Operation beyond the specified temperature range is achieved.

**XTR1N0415 ELECTRICAL SPECIFICATIONS**

 Unless otherwise stated, specification applies for one diode and  $-60^{\circ}\text{C} < T_j < 230^{\circ}\text{C}$ .

Parameter	Condition	Min	Typ	Max	Units
<b>Electrical Characteristics</b>					
Forward Voltage $V_F$	$I_F=1\text{mA}$ $T_C=-60^{\circ}\text{C}$ $T_C=85^{\circ}\text{C}$ $T_C=230^{\circ}\text{C}$		844 622 375		mV
Forward Current $I_F$	$V_F=1.2\text{V}$ $T_C=-60^{\circ}\text{C}$ $T_C=85^{\circ}\text{C}$ $T_C=230^{\circ}\text{C}$		215 255 280		mA
Reverse Current $I_R$	$V_R=40\text{V}$ $T_C=-60^{\circ}\text{C}$ $T_C=85^{\circ}\text{C}$ $T_C=230^{\circ}\text{C}$		<0.002 0.004 2.0		$\mu\text{A}$
<b>Switching Characteristics</b>					
Diode Capacitance $C_d$	$F=200\text{KHz}$ , $V_R=0\text{V}$ , $T_C=230^{\circ}\text{C}$ $F=200\text{KHz}$ , $V_R=40\text{V}$ , $T_C=230^{\circ}\text{C}$		100 21		pF
Reverse Recovery Time $t_{rr}$	$I_F = I_{Im} = 100\text{ mA}$ , $t_{rr}$ at 25% of $I_{Im}$ $T_C=-60^{\circ}\text{C}$ $T_C=85^{\circ}\text{C}$ $T_C=230^{\circ}\text{C}$		18 25 32		ns
	$I_F = 100\text{ mA}$ , $V_R = -6\text{V}$ , $t_{rr}$ at 25% of $I_{Im}$ $T_C=-60^{\circ}\text{C}$ $T_C=85^{\circ}\text{C}$ $T_C=230^{\circ}\text{C}$		19 30 38		ns

**XTR1N0450 ELECTRICAL SPECIFICATIONS**

 Unless otherwise stated, specification applies for one diode and  $-60^{\circ}\text{C} < T_j < 230^{\circ}\text{C}$ .

Parameter	Condition	Min	Typ	Max	Units
<b>Electrical Characteristics</b>					
Forward Voltage $V_F$	$I_F=1\text{mA}$ $T_C=-60^{\circ}\text{C}$ $T_C=85^{\circ}\text{C}$ $T_C=230^{\circ}\text{C}$		830 585 315		mV
Forward Current $I_F$	$V_F=1.2\text{V}$ $T_C=-60^{\circ}\text{C}$ $T_C=85^{\circ}\text{C}$ $T_C=230^{\circ}\text{C}$		640 730 800		mA
Reverse Current $I_R$	$V_R=40\text{V}$ $T_C=-60^{\circ}\text{C}$ $T_C=85^{\circ}\text{C}$ $T_C=230^{\circ}\text{C}$		<0.005 0.015 10		$\mu\text{A}$
<b>Switching Characteristics</b>					
Diode Capacitance $C_d$	$F=200\text{KHz}$ , $V_R=0\text{V}$ , $T_C=230^{\circ}\text{C}$ $F=200\text{KHz}$ , $V_R=40\text{V}$ , $T_C=230^{\circ}\text{C}$		330 73		pF
Reverse Recovery Time $t_{rr}$	$I_F = I_{Im} = 100\text{ mA}$ , $t_{rr}$ at 25% of $I_{Im}$ $T_C=-60^{\circ}\text{C}$ $T_C=85^{\circ}\text{C}$ $T_C=230^{\circ}\text{C}$		30 40 55		ns
	$I_F = 100\text{ mA}$ , $V_R = -6\text{V}$ , $t_{rr}$ at 25% of $I_{Im}$ $T_C=-60^{\circ}\text{C}$ $T_C=85^{\circ}\text{C}$ $T_C=230^{\circ}\text{C}$		35 52 65		ns

## XTR1N0415 TYPICAL PERFORMANCE

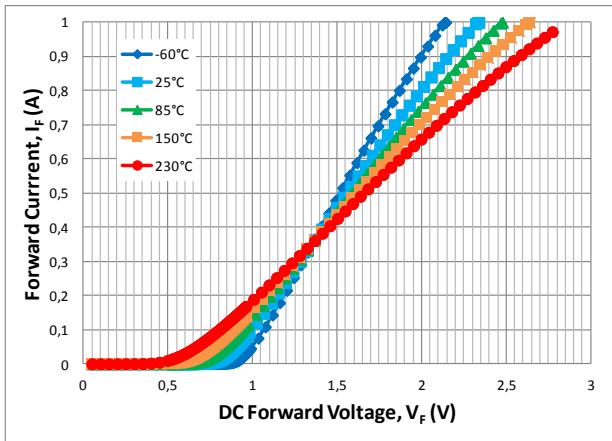

Figure 1. Forward current ( $I_F$ ) vs DC forward voltage ( $V_F$ ) for several case temperatures. Linear vertical axis.

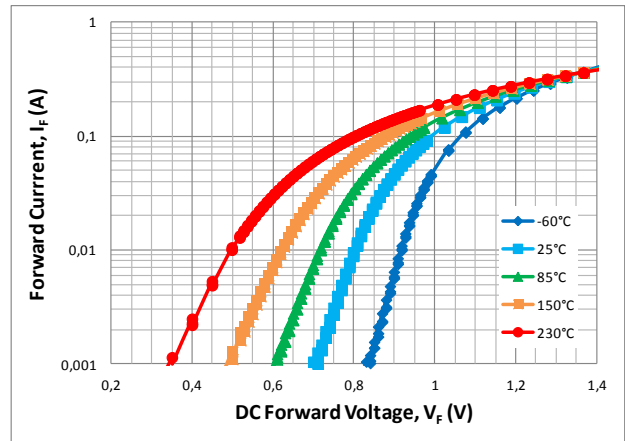

Figure 2. Forward current ( $I_F$ ) vs DC forward voltage ( $V_F$ ) for several case temperatures. Logarithmic vertical axis.

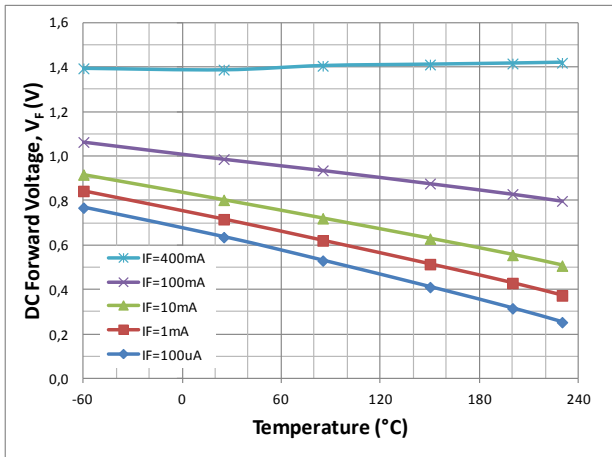

Figure 3. DC forward voltage ( $V_F$ ) vs case temperature for several forward currents ( $I_F$ ).

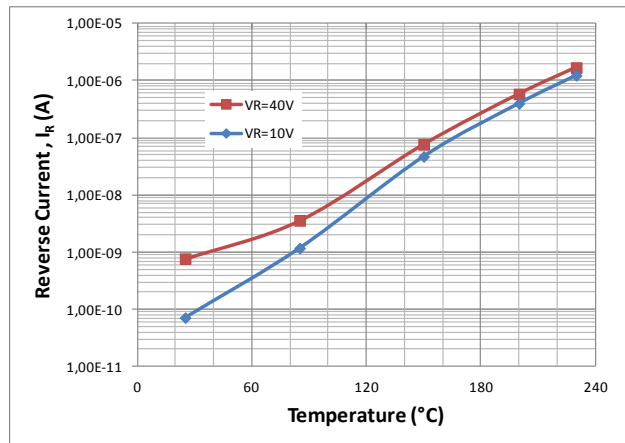

Figure 4. Reverse current ( $I_R$ ) vs case temperature for two reverse voltages ( $V_R$ ).

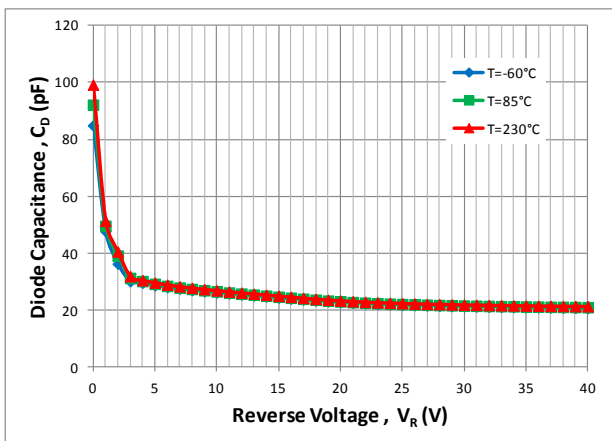

Figure 5. Diode capacitance ( $C_D$ ) vs reverse voltage ( $V_R$ ) for several case temperatures ( $I_F$ ) with  $F=200KHz$ .

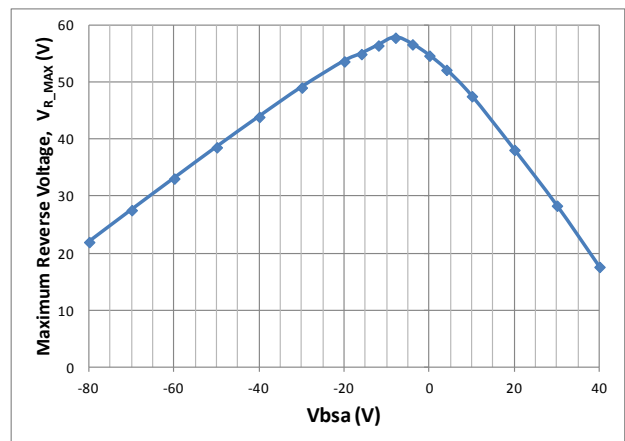

Figure 6. Maximum allowed reverse voltage ( $V_{R\_MAX}$ ) vs back-side to anode voltage (see Block Diagram in page 3). Worst case values.

XTR1N0450 TYPICAL PERFORMANCE

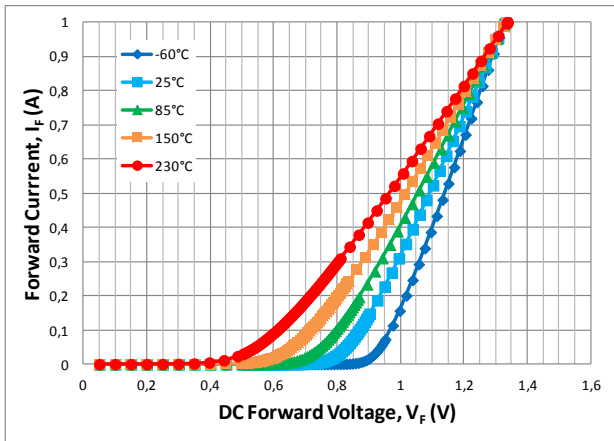

Figure 7. Forward current ( $I_F$ ) vs DC forward voltage ( $V_F$ ) for several case temperatures. Linear vertical axis.

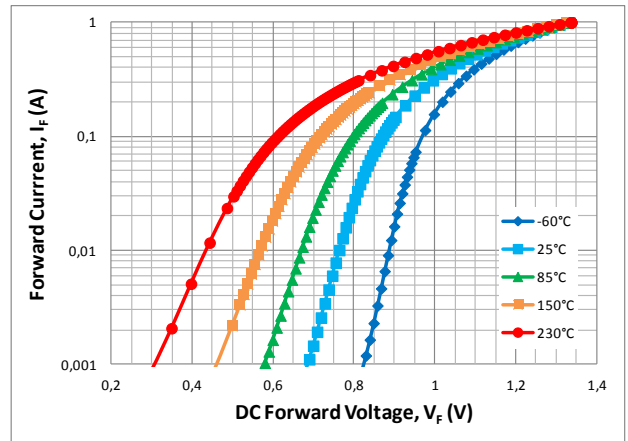

Figure 8. Forward current ( $I_F$ ) vs DC forward voltage ( $V_F$ ) for several case temperatures. Logarithmic vertical axis.

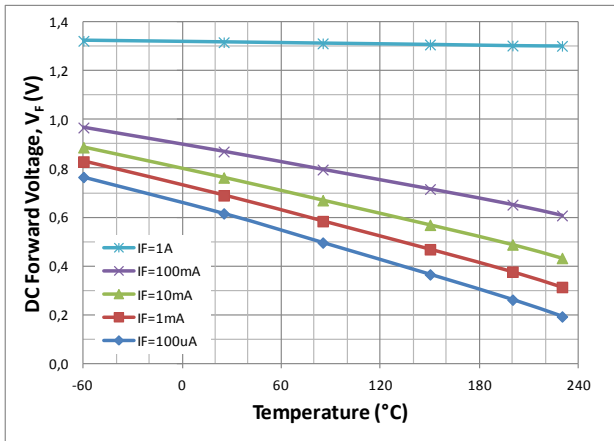

Figure 9. DC forward voltage ( $V_F$ ) vs case temperature for several forward currents ( $I_F$ ).

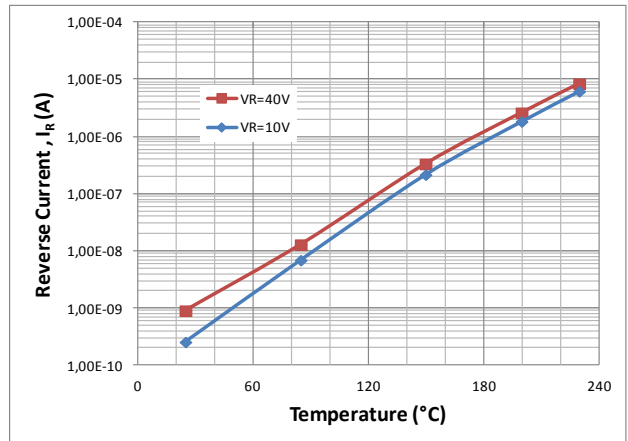

Figure 10. Reverse current ( $I_R$ ) vs case temperature for two reverse voltages ( $V_R$ ).

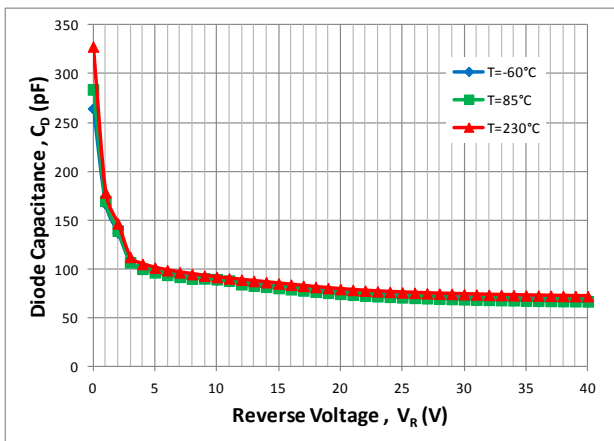

Figure 11. Diode capacitance ( $C_D$ ) vs reverse voltage ( $V_R$ ) for several case temperatures ( $I_F$ ) with  $F=200KHz$ .

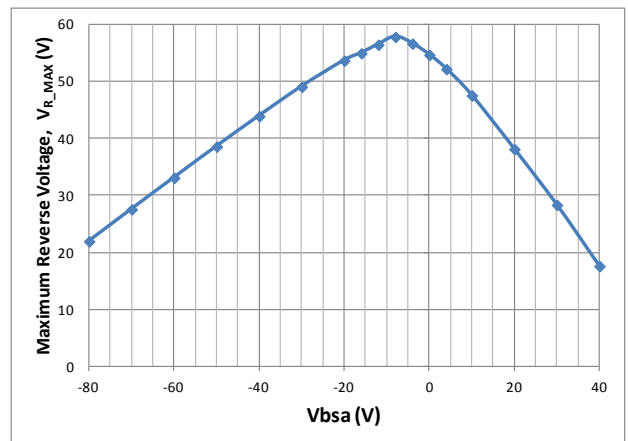

Figure 12. Maximum allowed reverse voltage ( $V_{R\_MAX}$ ) vs back-side to anode voltage (see Block Diagram in page 3). Worst case values.

**PARAMETER DEFINITION (TRR)**

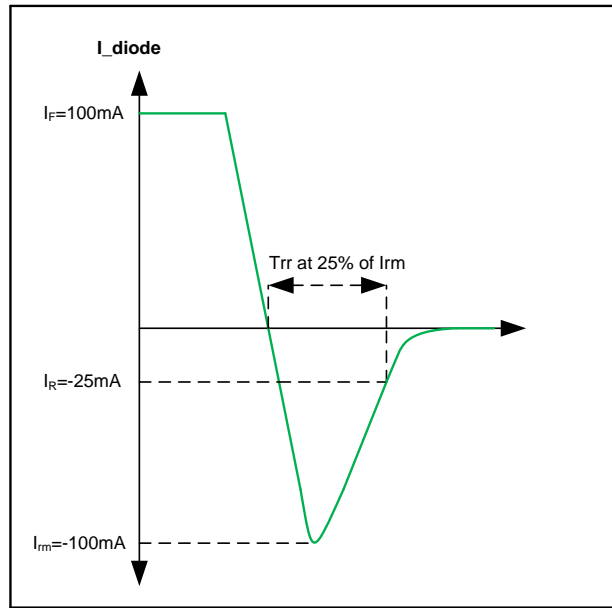

Figure 13. Reverse recovery time definition for  $I_F = I_{RM} = 100\text{mA}$ .

**THEORY OF OPERATION**

**Introduction**

The XTR1N0400 is a family of general purpose diodes able to operate from -60°C to +230°C and withstand reverse voltages up to 55V.

Each die is composed of four independent diodes on top of the same silicon substrate (back-side connection).

Given the construction of the diodes, the back-side voltage has an influence on the maximum allowed reverse voltage. Optimum performance is achieved for the back-side connected to the most negative voltage seen by any of the four diodes.

In TO18 packaged parts, the back-side is connected to the cathode of the first diode (CATHODE1) and the anode of the second diode (ANODE2).

In DIP8 and CDFP8 packaged parts, the back-side is connected to the anode of the first diode (ANODE1).

In the simple full-wave rectifier example below, if DIP8 or CDFP8 packaged versions of XTR1N0415 or XTR1N0450 are used, the optimum result in terms of reverse voltage robustness is achieved by connecting the anode of the first diode to the GND node.

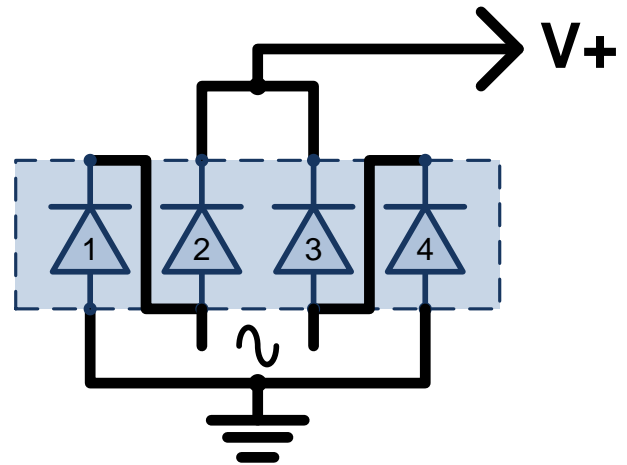

The previous figure shows a simple implementation of the full-bridge rectifier at board level. Bold black lines indicate tracks on the board. In this configuration, as recommended in the previous figure, the anode of the first diode is connected to the GND node in order to offer the best reverse voltage characteristics.

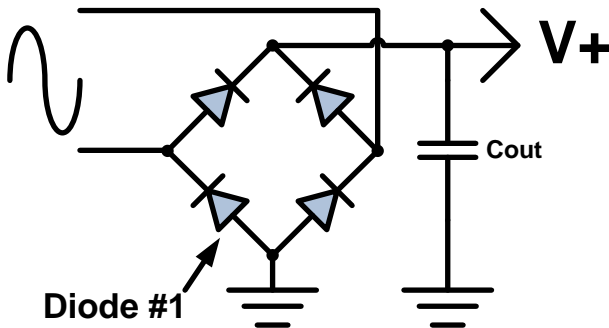



## PACKAGE OUTLINES

Dimensions shown in mm [inches]. Tolerance  $\pm 0.13$  mm [ $\pm 0.005$  in], unless otherwise specified.

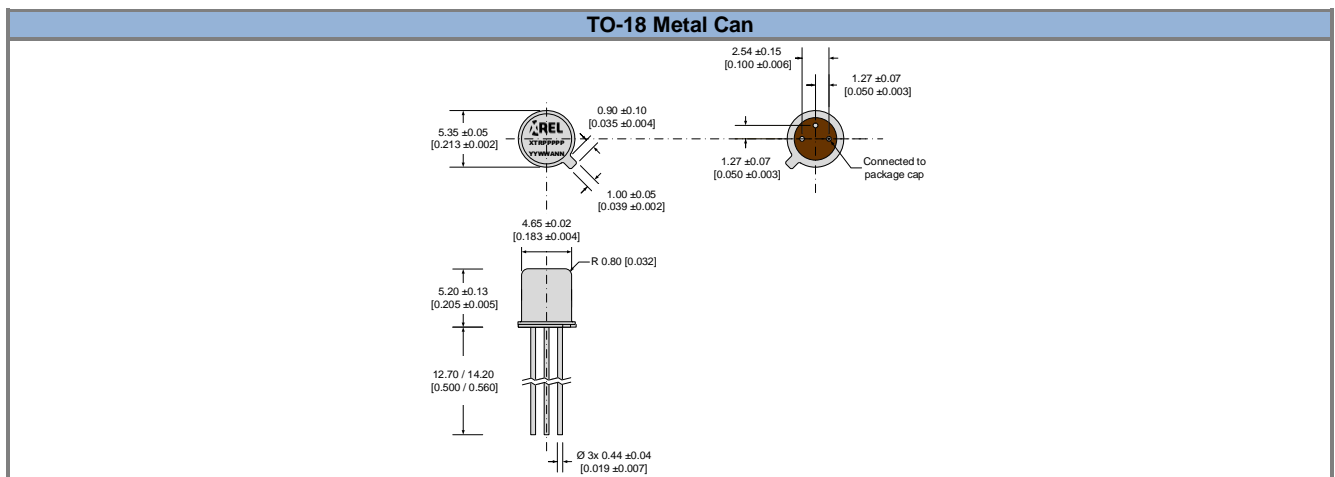
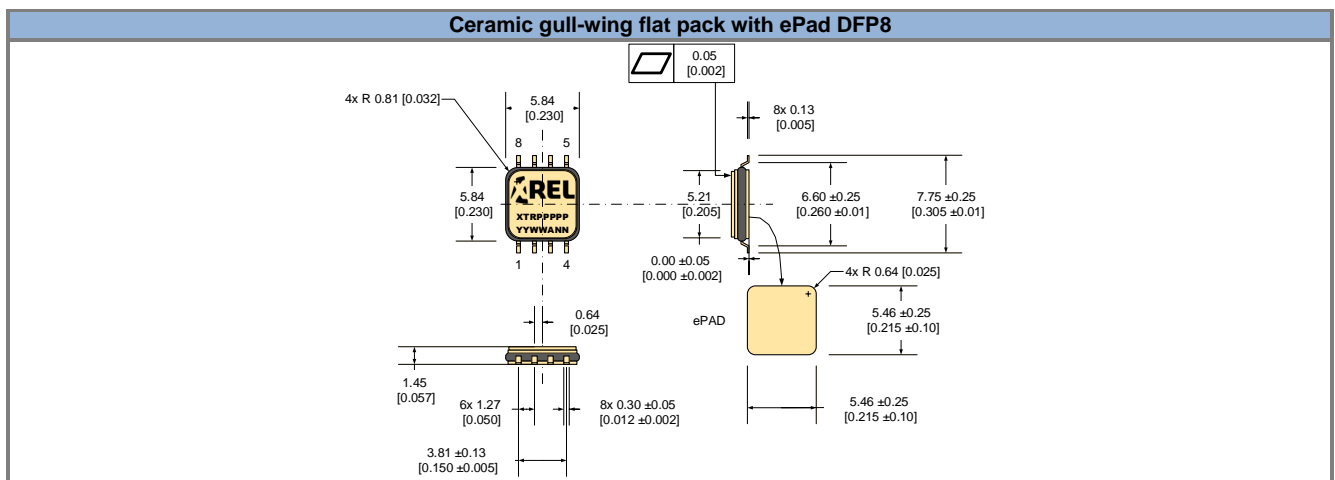
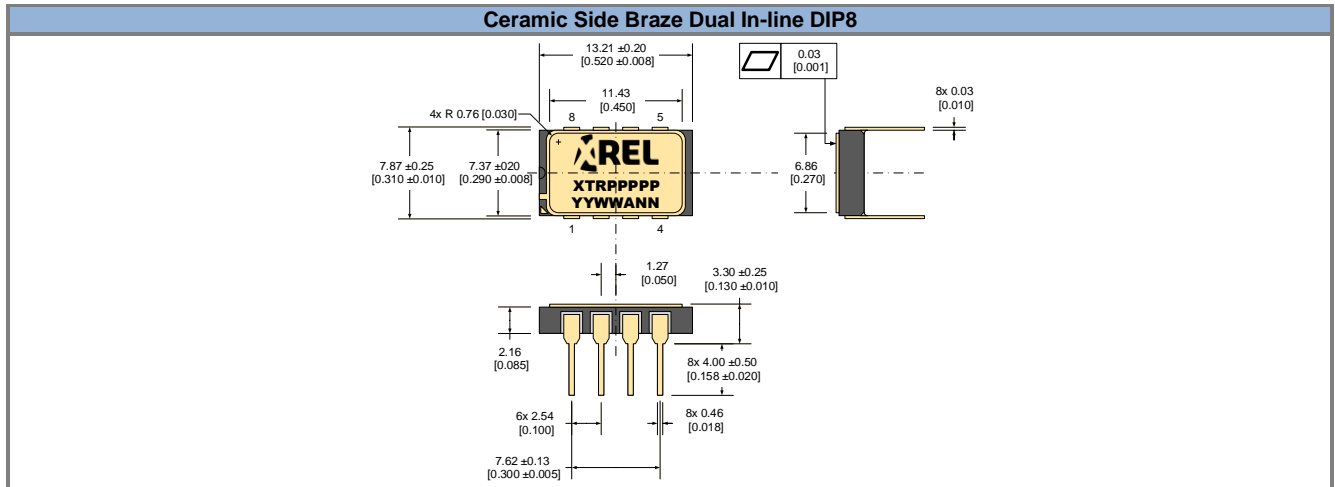

### Part Marking Convention

<b>Part Reference: XTRPPPPPP</b>	
<b>XTR</b>	X-REL Semiconductor, high-temperature, high-reliability product (XTRM Series).
<b>PPPPP</b>	Part number (0-9, A-Z).
<b>Unique Lot Assembly Code: YYWWANN</b>	
<b>YY</b>	Two last digits of assembly year (e.g. 11 = 2011).
<b>WW</b>	Assembly week (01 to 52).
<b>A</b>	Assembly location code.
<b>NN</b>	Assembly lot code (01 to 99).

**IMPORTANT NOTICE & DISCLAIMER**

Information in this document supersedes and replaces all information previously supplied. Information in this document is provided solely in connection with X-REL Semiconductor products.

The information contained herein is believed to be reliable. X-REL Semiconductor makes no warranties regarding the information contained herein. X-REL Semiconductor assumes no responsibility or liability whatsoever for any of the information contained herein. X-REL Semiconductor assumes no responsibility or liability whatsoever for the use of the information contained herein. The information contained herein is provided "AS IS, WHERE IS" and with all faults, and the entire risk associated with such information is entirely with the user. X-REL Semiconductor reserves the right to make changes, corrections, modifications or improvements, to this document and the information herein without notice. Customers should obtain and verify the latest relevant information before placing orders for X-REL Semiconductor products. The information contained herein or any use of such information does not grant, explicitly or implicitly, to any party any patent rights, licenses, or any other intellectual property rights, whether with regard to such information itself or anything described by such information.

Unless expressly approved in writing by an authorized representative of X-REL Semiconductor, X-REL Semiconductor products are not designed, authorized or warranted for use in military, aircraft, space, life saving, or life sustaining applications, nor in products or systems where failure or malfunction may result in personal injury, death, or property or environmental damage.

General Sales Terms & Conditions apply.

**CONTACT US**

For more information on X-REL Semiconductor's products, technical support or ordering:

- ✓ Web: [www.x-relsemi.com/products](http://www.x-relsemi.com/products)
- ✓ Tel: +33 456 580 580
- ✓ Fax: +33 456 580 599
- ✓ Sales: [sales@x-relsemi.com](mailto:sales@x-relsemi.com)  
[www.x-relsemi.com/EN/Sales-Representatives](http://www.x-relsemi.com/EN/Sales-Representatives)
- ✓ Information: [info@x-relsemi.com](mailto:info@x-relsemi.com)
- ✓ Support: [support@x-relsemi.com](mailto:support@x-relsemi.com)

**X-REL Semiconductor**

90, Avenue Léon Blum  
38100 Grenoble  
France